

# DEFLEX® FUGENSYSTEME

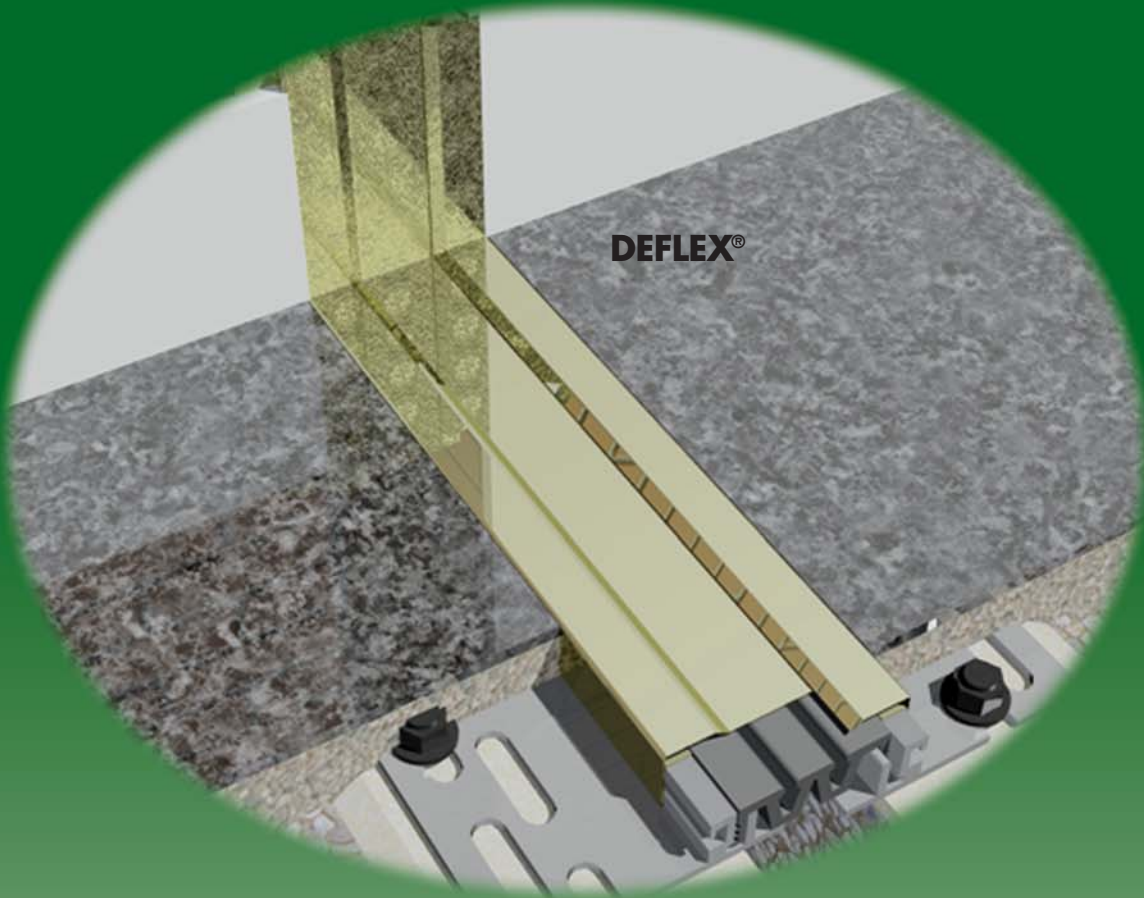

4.6

**DEKORATIVE FUGENABDECKUNGEN /  
DEFLEX® DESIGN**

*decorative joint coverings /  
DEFLEX® design*

# DEFLEX® Design 445/L

für Böden und Wände / for floors and walls

**Dekorative Fugenabdeckungen für anspruchsvolle Projekte mit hochwertigen Boden- und Wandbelägen. Faszinierende Oberflächen mit einer Vielzahl von Gestaltungsmöglichkeiten. Speziell entwickelt für Paläste, Gästehäuser, Hotels, Einkaufszentren etc..**

**Decorative joint covers for prestigious projects with high quality floor and wall finishes. Attractive finish of these profiles provides a range of design possibilities. Especially developed for palaces, company houses, hotels, shopping malls etc..**

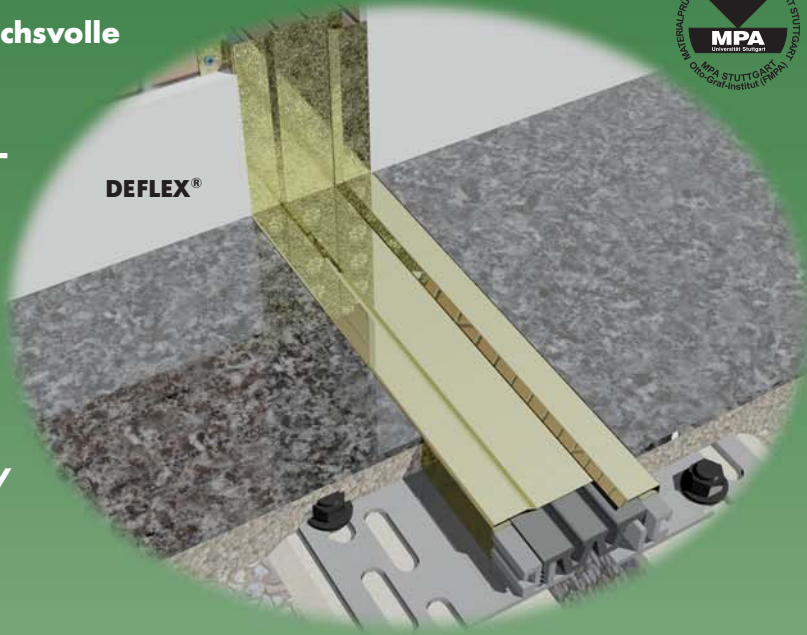

Geprüftes Brandverhalten gem. den Anforderungen an die Klasse E nach DIN EN 13501-1.

Tested fire behavior in accordance to the requirements of class E to DIN EN 13501-1.

Typ/ type	<b>445/L-050</b>
F <sub>b</sub> [mm] bis / up to	50
H [mm]	25 / 30 / 40 / 55
B [mm] ca. / approx.	180
S [mm] ca. / approx.	62
Bewegung / movement w [mm] horizontal	20 (±10)
Farbe der Einlage / insert colours	schwarz, grau / black, grey
Material / material	Nitriflex®, Aluminium, Messing, Edelstahl / Nitriflex®, aluminium, brass, stainless steel
Lieferlänge [m] standard length [m]	4
Belastbarkeit [kN] load-bearing capacity [kN]	

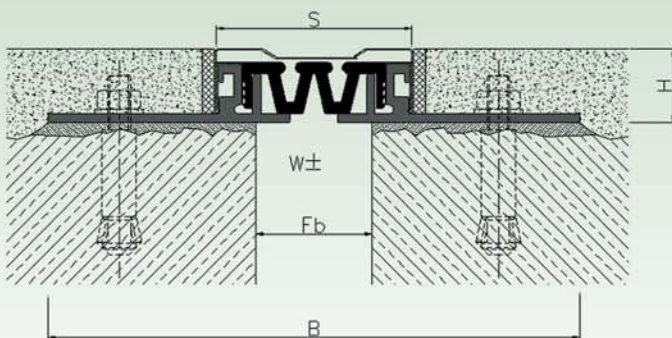

**445/L-050**

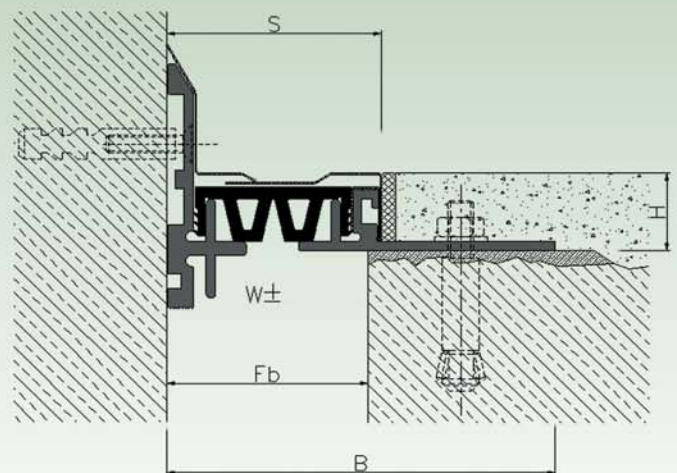

**E 445/L-050**

# DEFLEX® Design 446/cPL

für Böden und Wände / for floors and walls

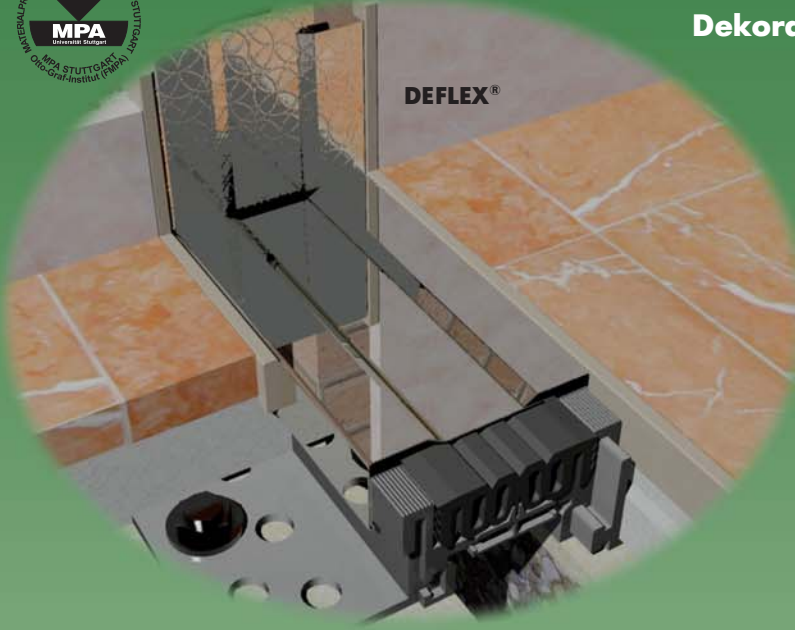

**Dekorative Fugenabdeckungen für anspruchsvolle Projekte mit hochwertigen Boden- und Wandbelägen. Faszinierende Oberflächen mit einer Vielzahl von Gestaltungsmöglichkeiten. Speziell entwickelt für Paläste, Gästehäuser, Hotels, Einkaufszentren etc..**

**Decorative joint covers for prestigious projects with high quality floor and wall finishes. Attractive finish of these profiles provides a range of design possibilities. Especially developed for palaces, company houses, hotels, shopping malls etc..**

Geprüftes Brandverhalten gem. den Anforderungen an die Klasse E nach DIN EN 13501-1.

Tested fire behavior in accordance to the requirements of class E to DIN EN 13501-1.



Typ/ type	<b>446/cPL-050</b>
F <sub>b</sub> [mm] bis / up to	50
H [mm]	40 / 45* / 55 / 60* / 65 / 85 / 105
B [mm] ca. / approx.	150 / 170
S [mm] ca. / approx.	62
Bewegung / movement w [mm] horizontal	20 (±10)
Farbe der Einlage / insert colours	schwarz, grau / black, grey
Material / material	Nitriflex®, Aluminium, Messing, Edelstahl / Nitriflex®, aluminium, brass, stainless steel
Lieferlänge [m] standard length [m]	4
Belastbarkeit [kN] load-bearing capacity [kN]	

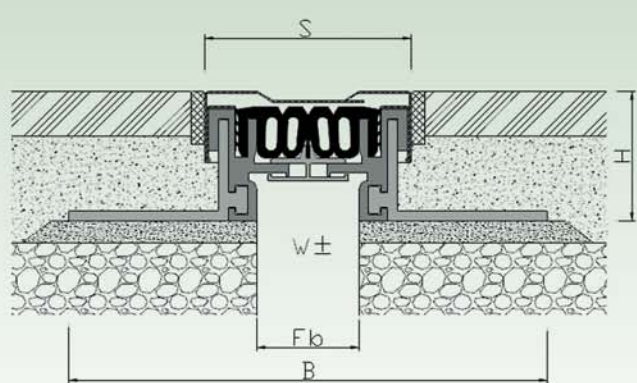

**446/cPL-050**

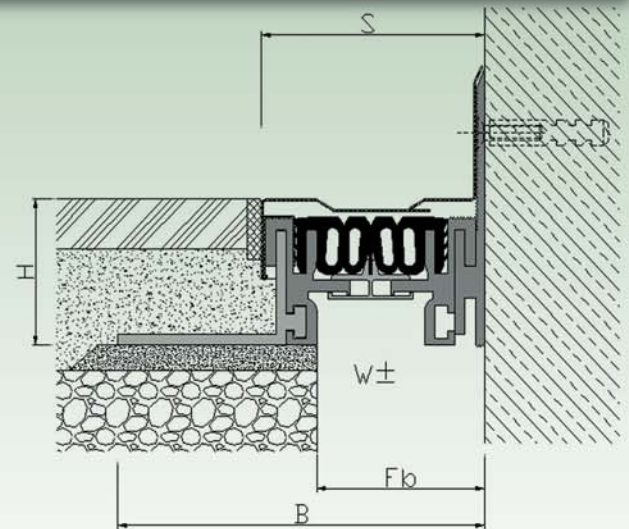

**E 446/cPL-050**

# DEFLEX® Design

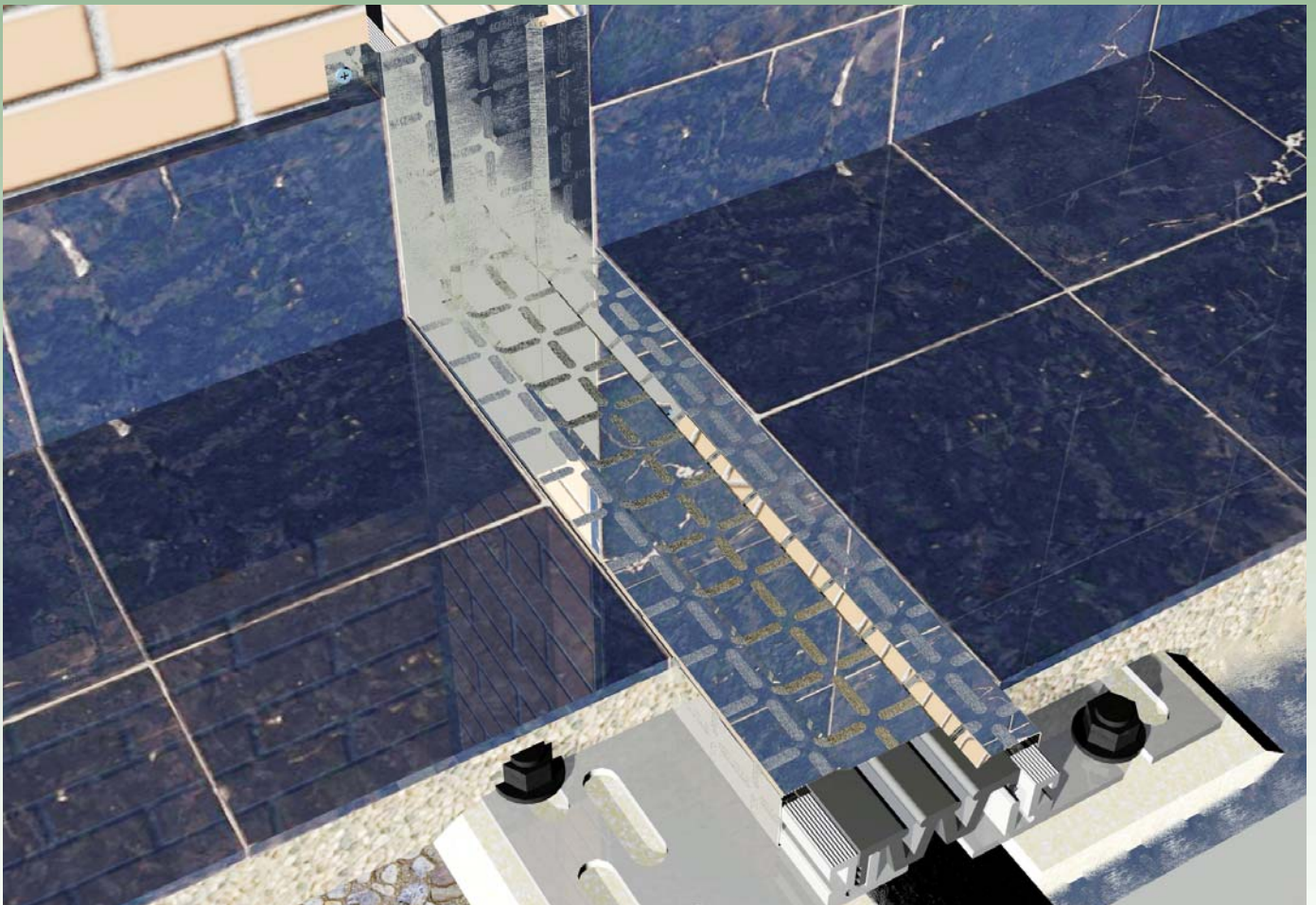
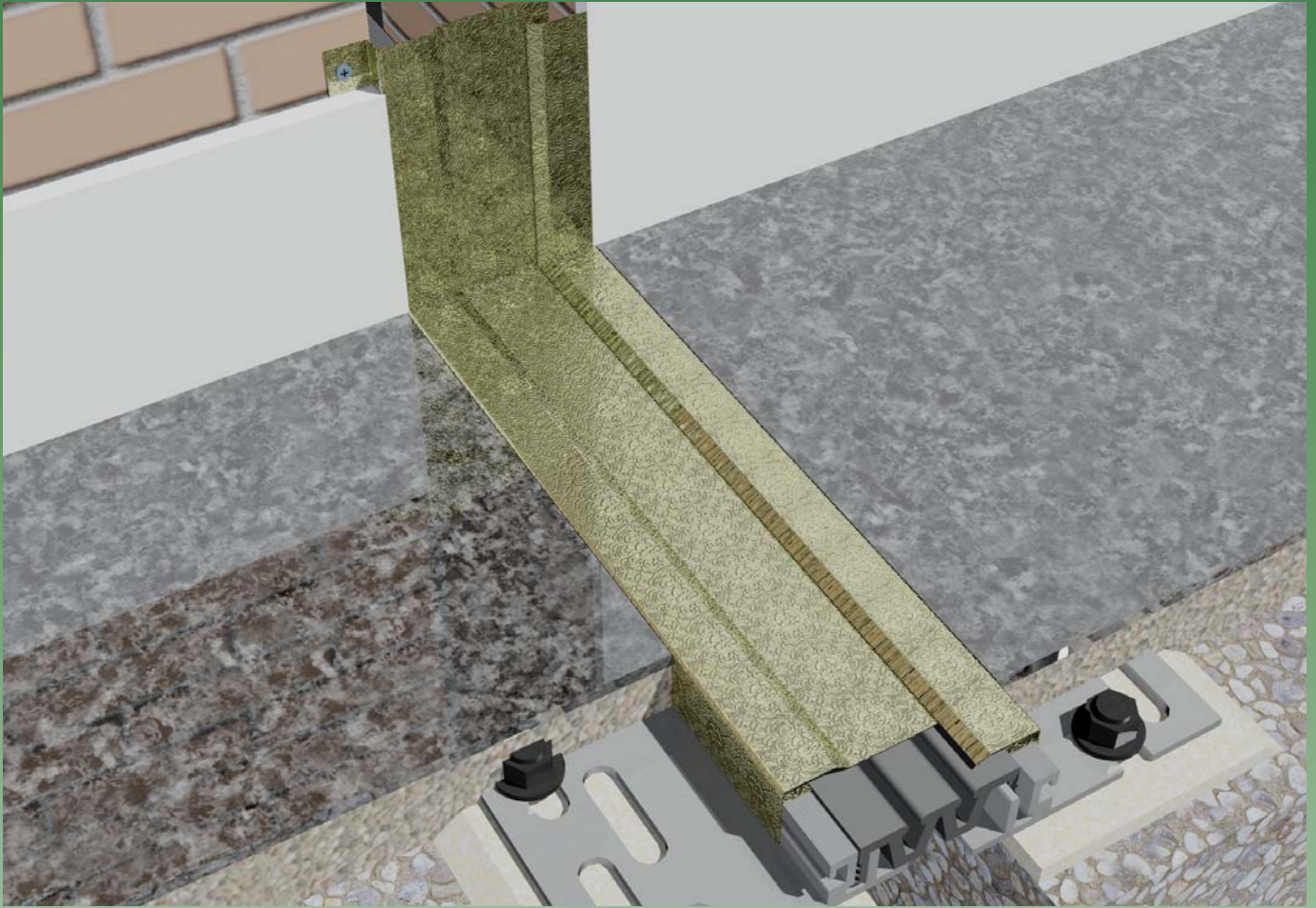

# DEFLEX® Design

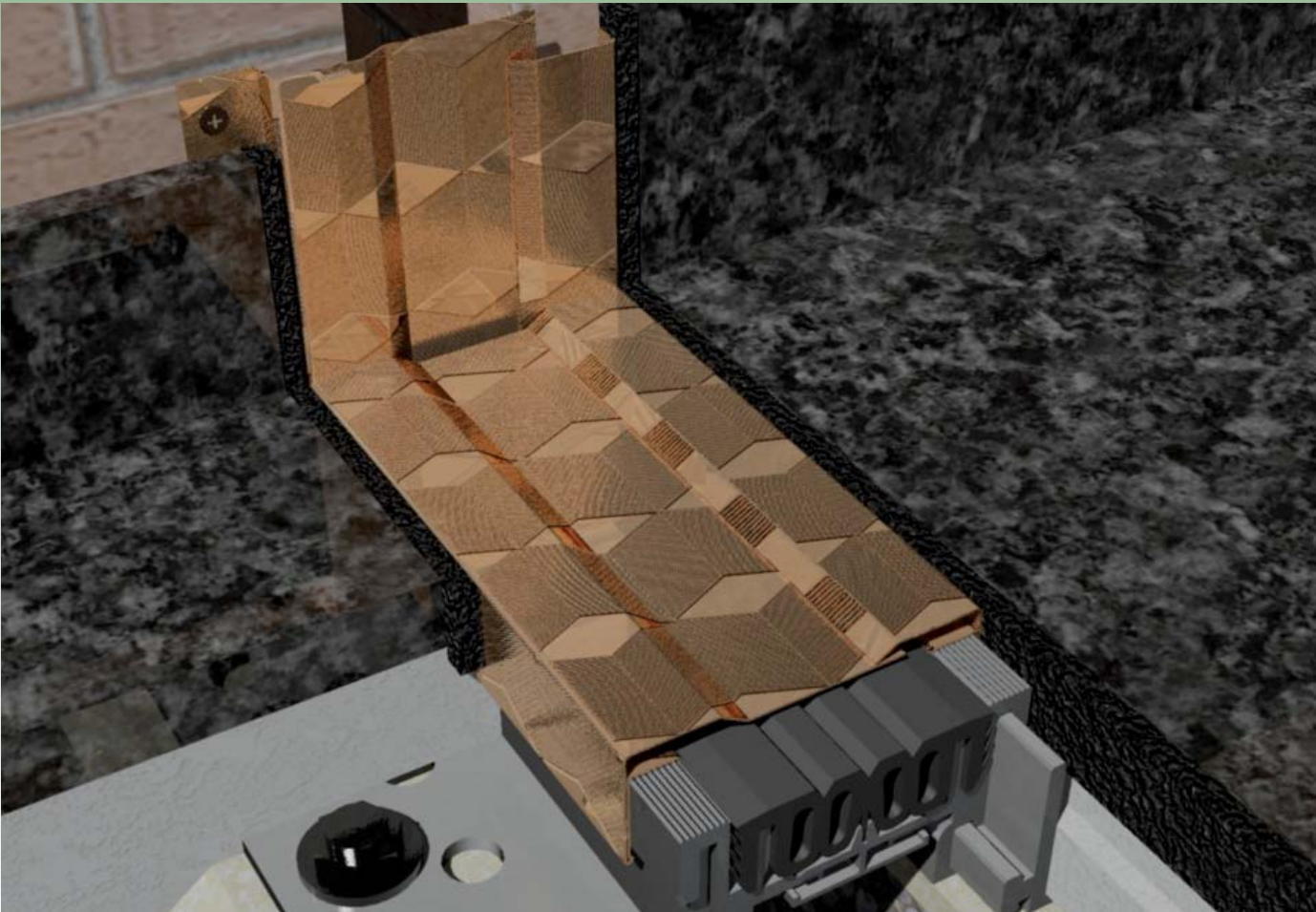
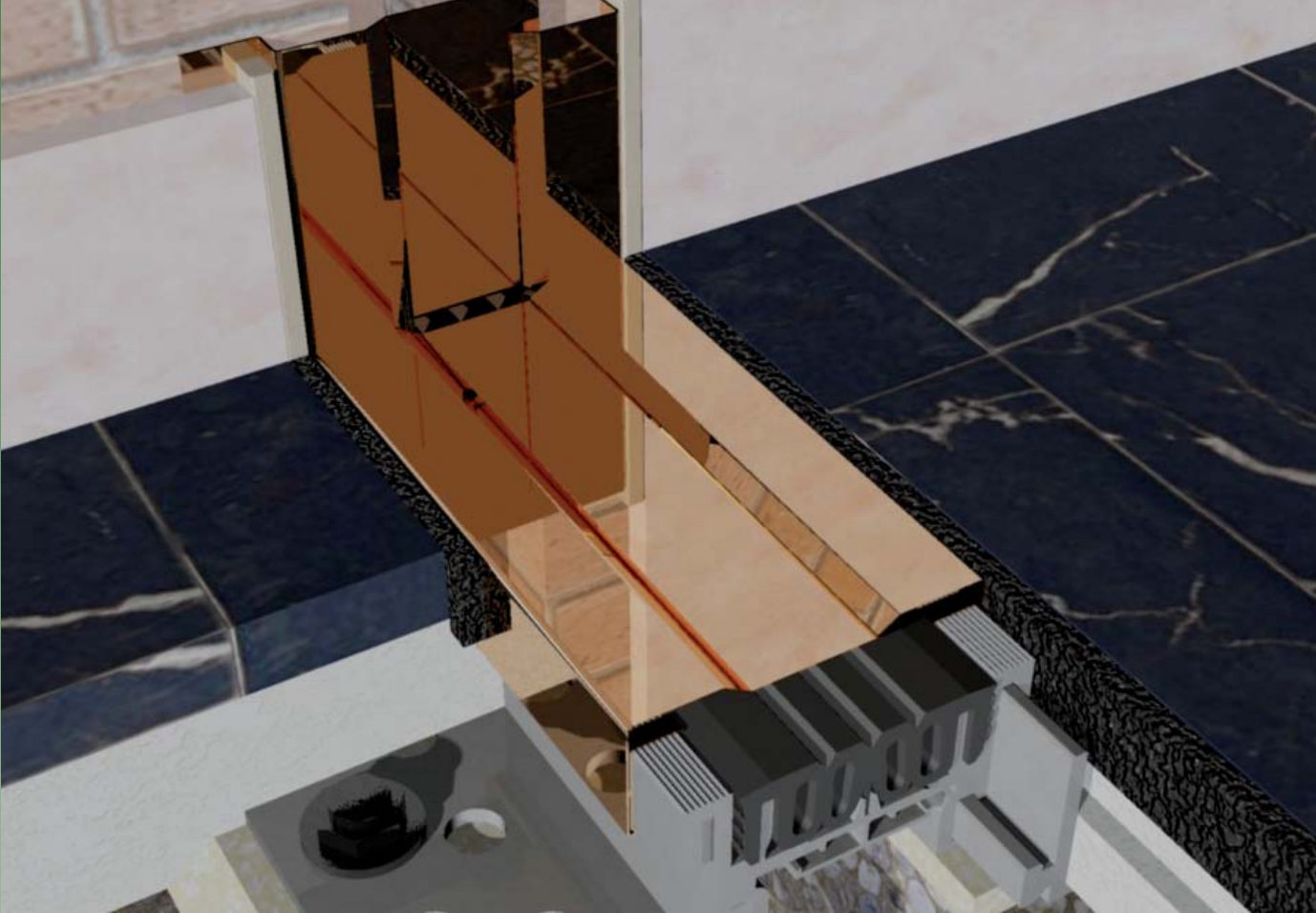

# DEFLEX® Design

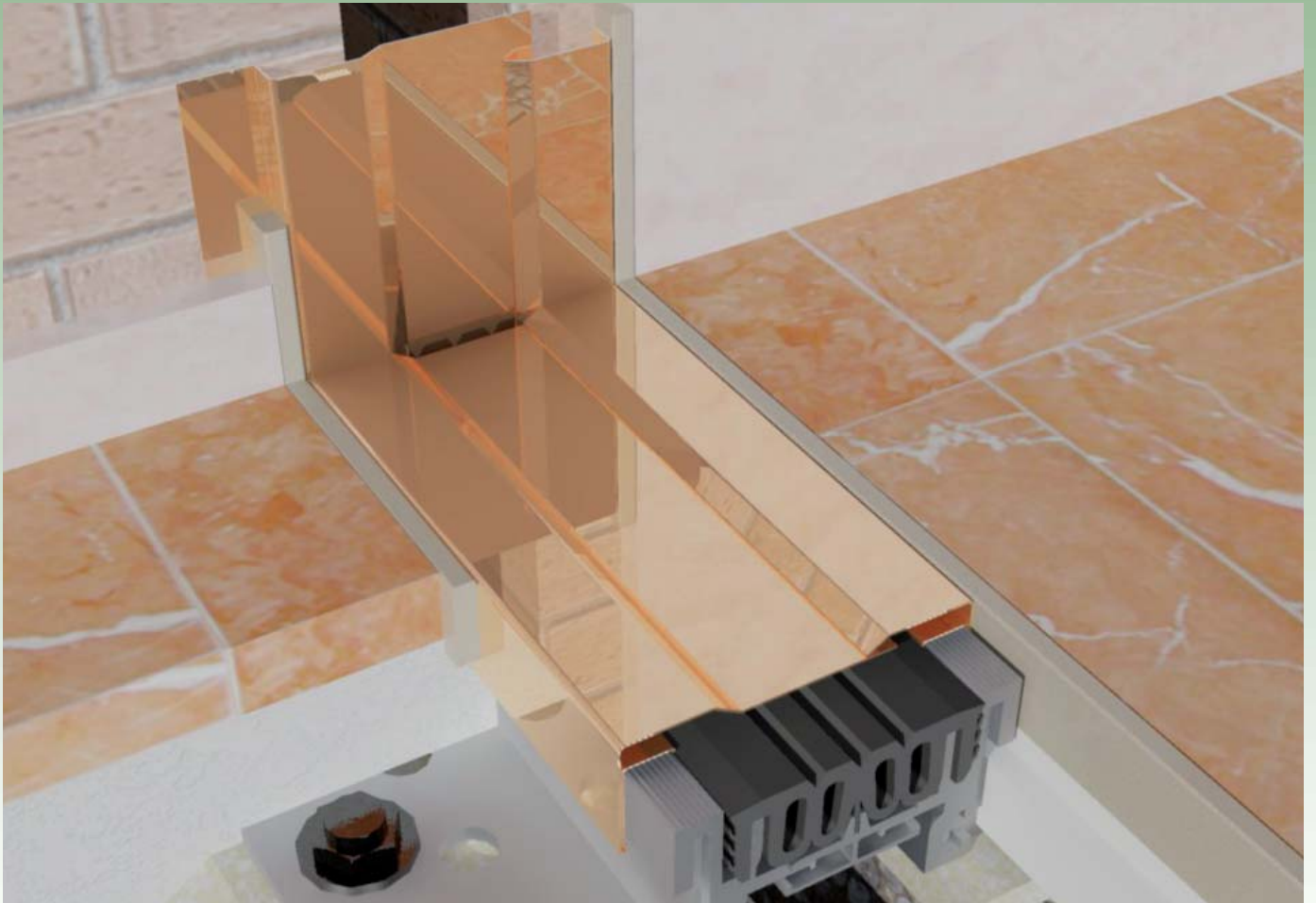
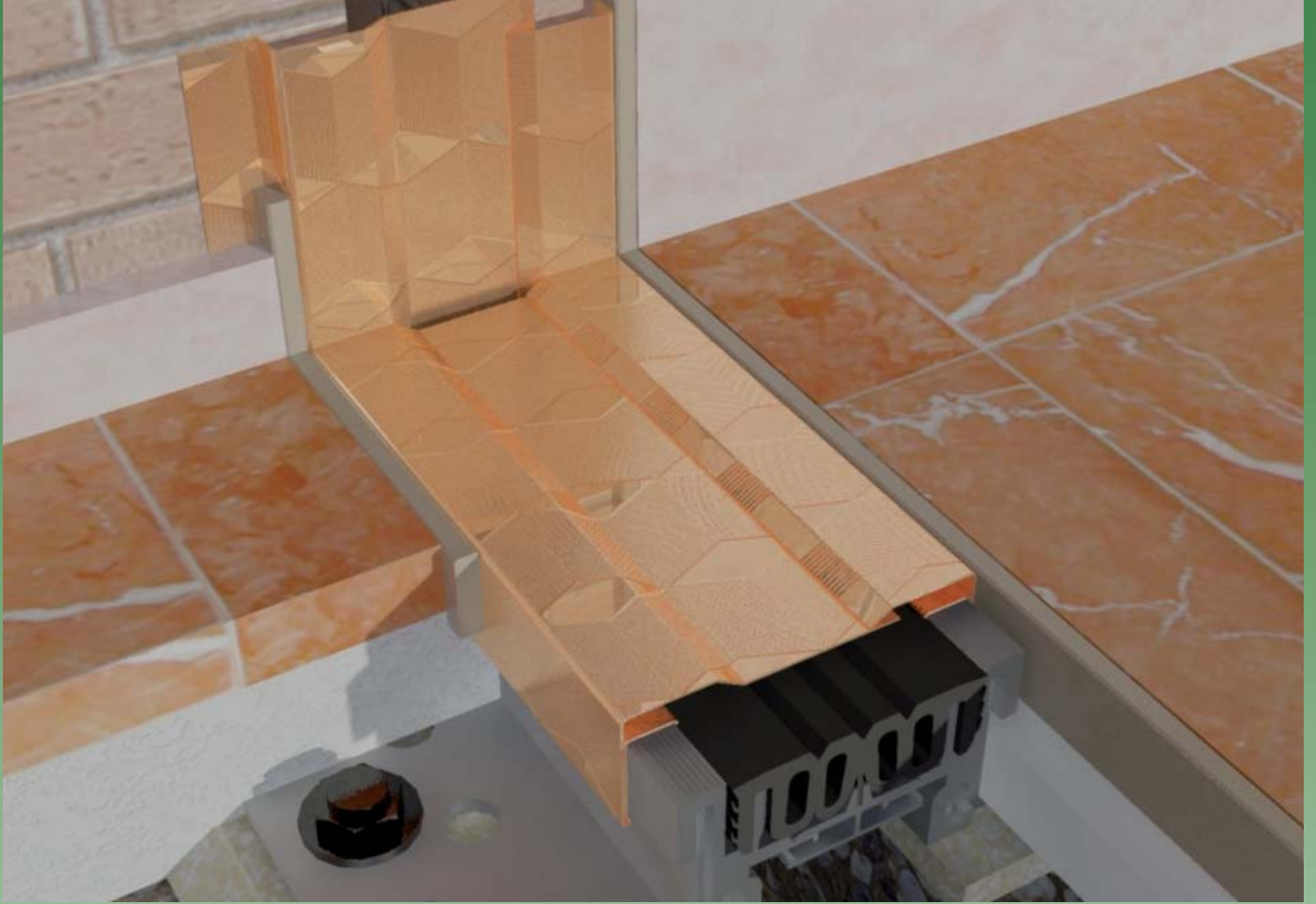

# DEFLEX® Design



90

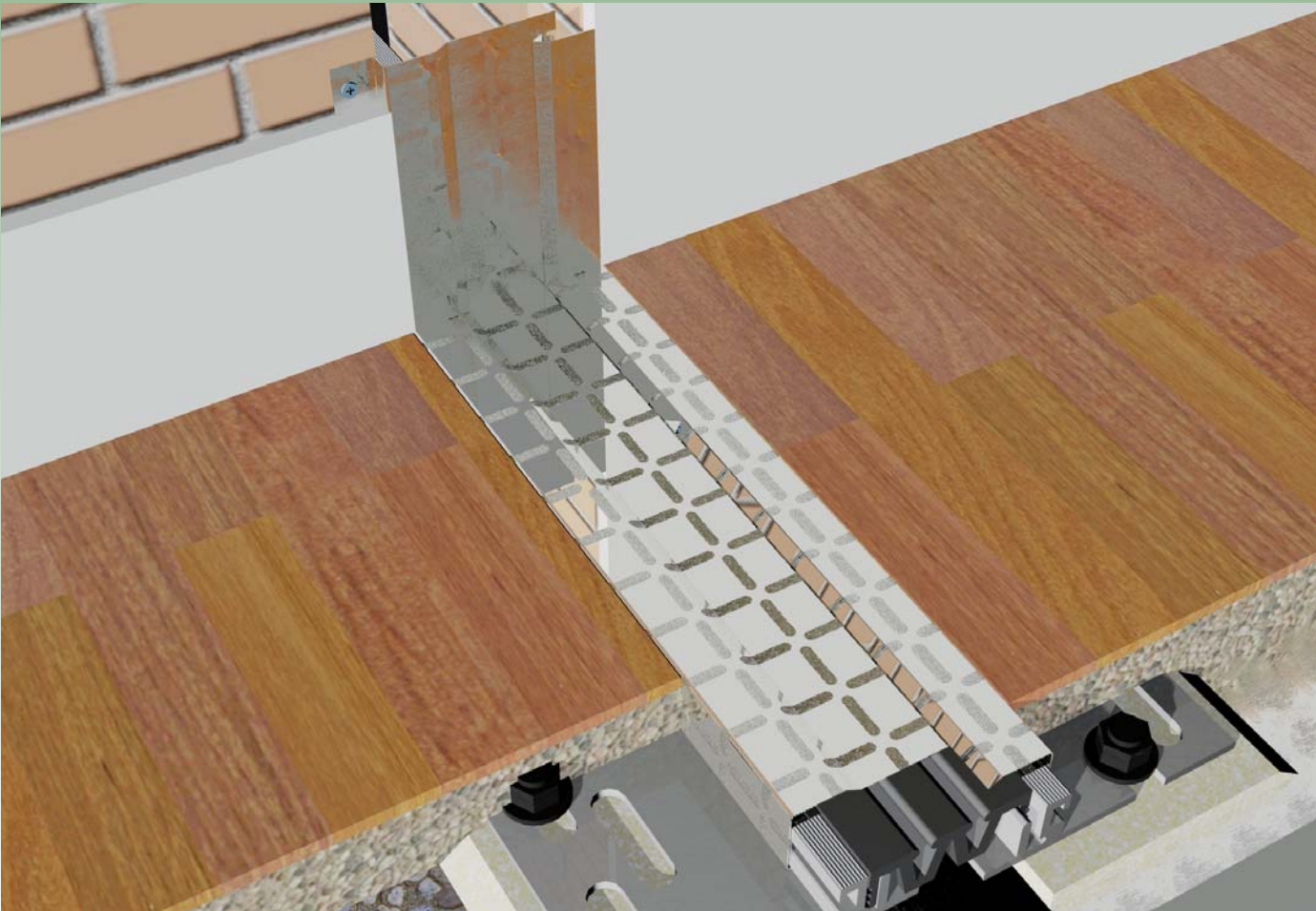

# DEFLEX® Design



Oriental



Major (glänzend / shiny)



Magic

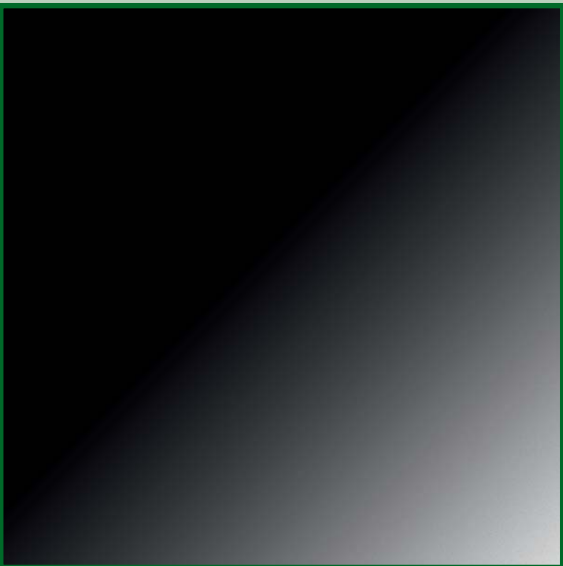

Mystical Night

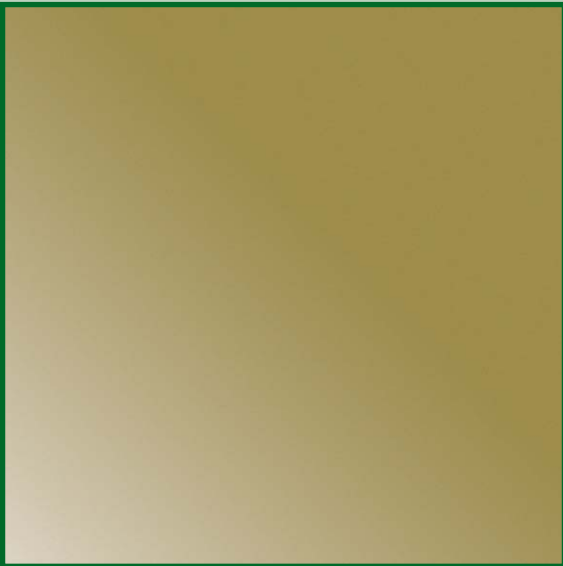

Mystic of Brass



# DEFLEX® Design

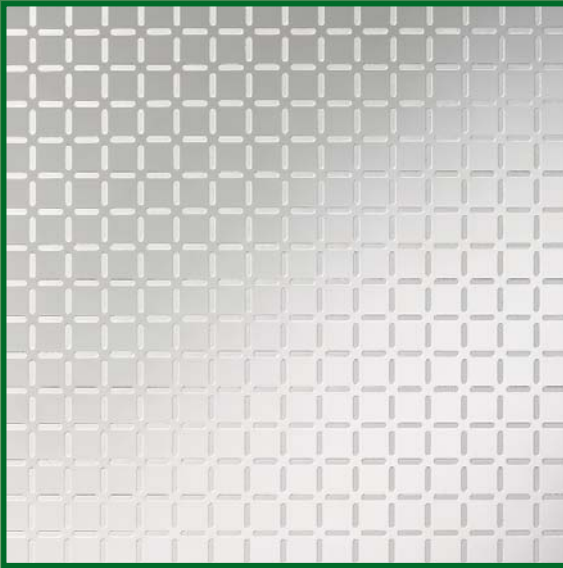

Mirror (glänzend / shiny)

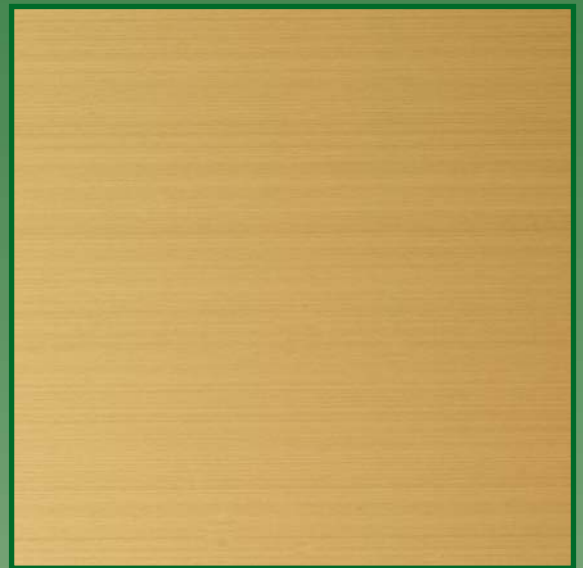

Gold Rain

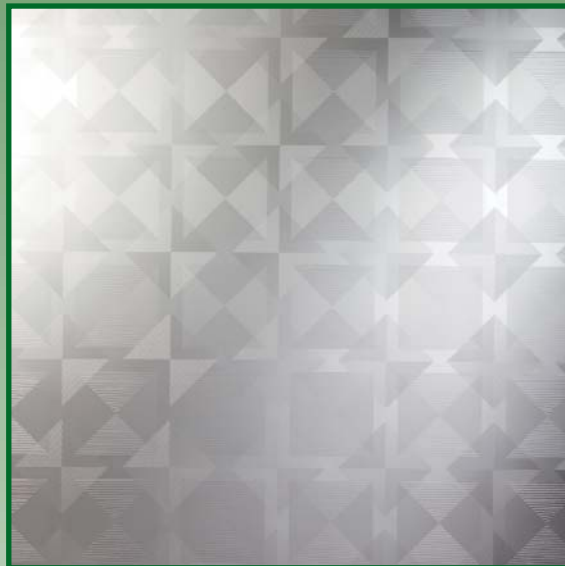

Star



Rain

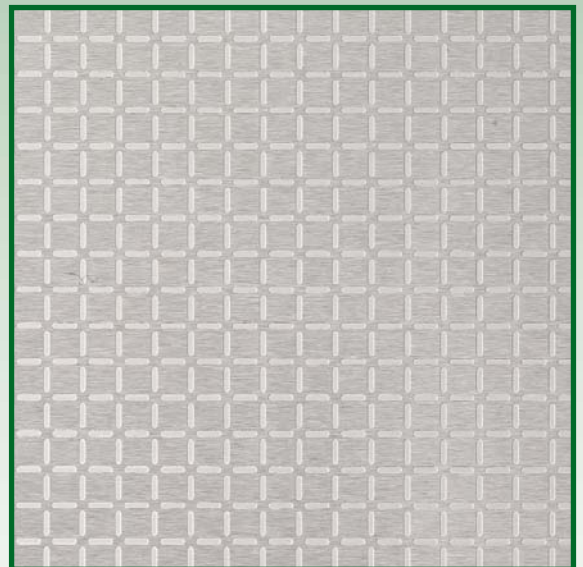

Frosted (matt / matt)

# DEFLEX® Design



World

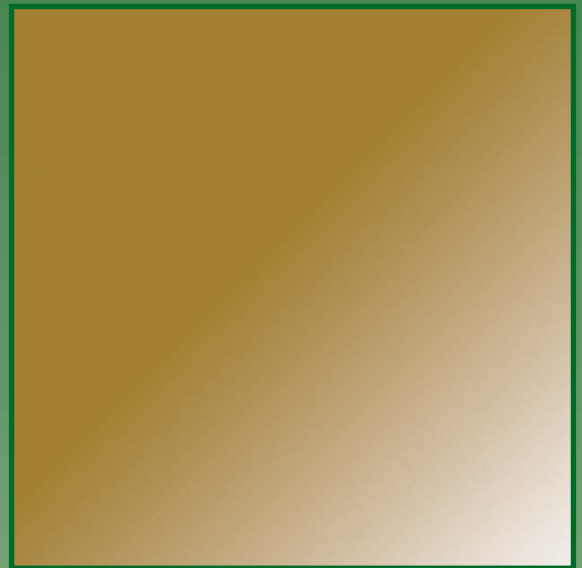

Majesty

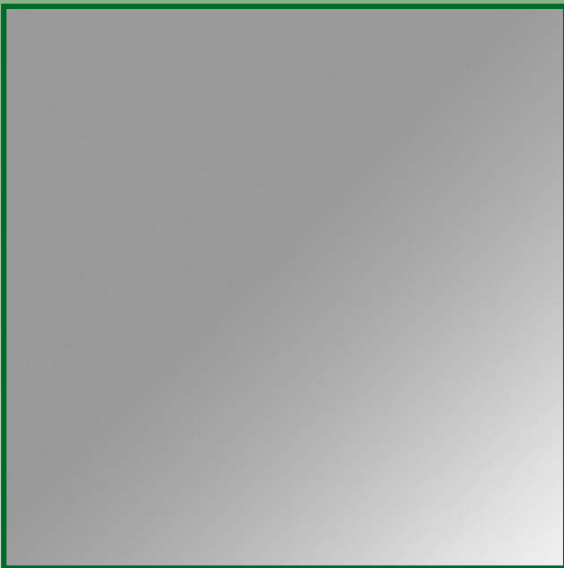

Enigma (matt / matt)



Snowflake

**Wir empfehlen folgende Typen für den Bodenbereich:**  
**We recommend the following types for the floors:**

- **Frosted**
- **Enigma**
- **Rain**
- **Edelstahl / Stainless Steel**
- **Messing / Brass**



# **DEFLEX®-FUGENSYSTEME GmbH**

EINSTEINSTRASSE 13 · D-46325 BORKEN/GERMANY  
TELEFON 00 49/28 61/9 24 41-0 · TELEFAX 00 49/28 61/9 24 41-50  
[www.deflex-fugensysteme.de](http://www.deflex-fugensysteme.de) · email: [info@deflex-fugensysteme.de](mailto:info@deflex-fugensysteme.de)